

013R9277

013R9277

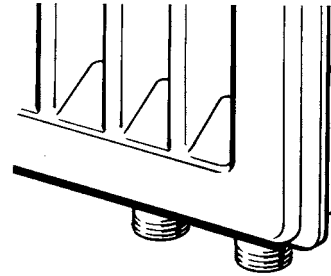
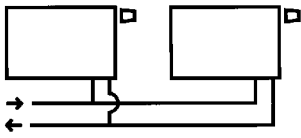

G 3/4 A

30 - 40 Nm

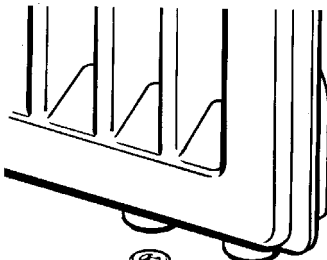
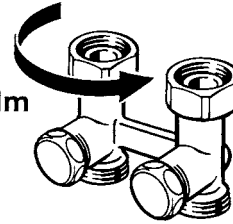

G 1/2

10 mm

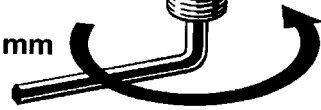

30 - 40 Nm

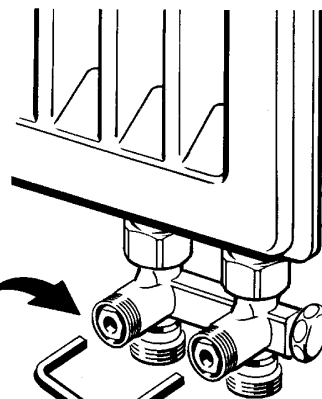
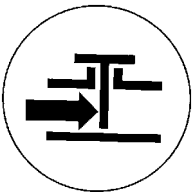
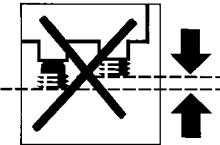
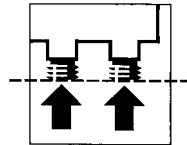
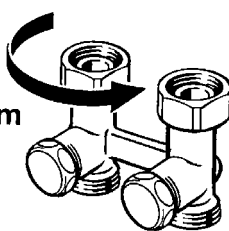

6 mm